

IN LINE SILENCER SILENZIATORE IN LINEA SERIES/SERIE SI

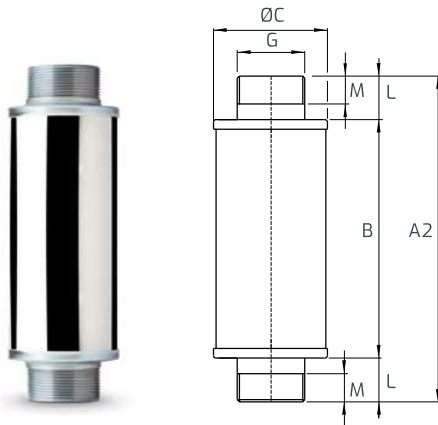

Dimensions \ Ingombri

Mod	DN	A2 (mm)	B (mm)	ØC (mm)	G (?)	L (mm)	M (mm)	Weight Peso (Kg)
SI4	32	210	140	72,4	G1 ¹ / ₄	35	20	0,83
SI5	40	240	170	81,9	G1 ¹ / ₂	35	22	1,06
SI6	50	290	200	91,6	G2"	45	25	1,5
SI8	80	435	345	152,6	G3"	45	30	3,56
SI9	100	485	430	169	G4"	27	20	3,90
SI9N	100	485	430	169	4"NPT	27	20	3,90

FINAL SILENCER SILENZIATORE FINALE SERIES/SERIE SS

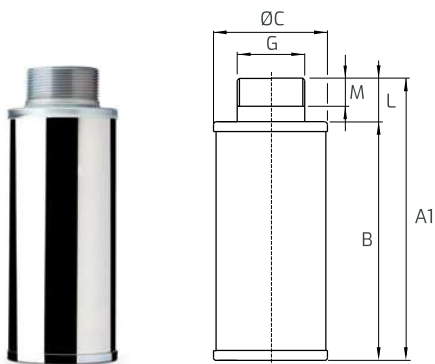

Dimensions \ Ingombri

Mod	DN	A1 (mm)	B (mm)	ØC (mm)	G (?)	L (mm)	M (mm)	Weight Peso (Kg)
SS4	32	173	138	72,8	G1 ¹ / ₄	35	20	0,66
SS5	40	202	167	82,1	G1 ¹ / ₂	35	22	0,89
SS6	50	245	200	91,6	G2"	45	25	1,26
SS8	80	395	350	152,5	G3"	45	30	3,19
SS9	100	465	430	169	G4"	27	20	4,10
SS9N	100	465	430	169	4"NPT	27	20	4,10