

		<h1>IE2 / Weitspannung</h1>	<b>Seitenkanalverdichter</b>
SKVTechnik skvtechnik@gmail.com www.skvtechnik.de	Tel.: +49 3741 2510951 Fax.: +49 3741 2510952 Funk: +49 172 7799600		<b>S3-1-210-1,5kW-3  1063 E</b> 1,5 kW / 1,8 kW [50 Hz / 60 Hz]

Technische Eigenschaften	Elektromotor	Optionen
Konstruktion aus Aluminiumlegierung	Schutzart IP55	Schutzart IP55
Vibrationslose ruhige Betriebsweise	Betrieb mit FU möglich	Abgedichtete Version
Wartungsfrei	Thermokontakt (PTO)	Unlackierte Ausführung

S3-1 210 m³/h  1,5 kW  +190 mbar  -200 mbar  3Phasen Motor															
Frequenz / Frequency	Grenzwerte der Drosselkurve im Überdruck		Grenzwerte der Drosselkurve im Unterdruck		Motorkennwerte			Schalldruckpegel	Sound pressure level	Gewicht (ca.)	Weight (approx.)	Druckanschluss	Pressure port diameter	Sauganschluss	Suction port diameter
	Maximum performance used as blower		Maximum performance as extractor		Motor ratings										
	V max.	delta P max.	V max.	delta P max.	Leistung	Spannung	Strom								
Hz	m³ / min	mbar	m³ / min	mbar	kW	V	A	dB (A)	kg	Zoll (")	Zoll (")				
50	3,5 210	200	3,5 210	190	1,5	207-253 / 360-440	7,5 / 4,3	64	23	2 Zoll	2 Zoll				
60	4,25 255	220	4,25 255	210	1,8	220-250 / 415-480	8,0 / 4,6	70							

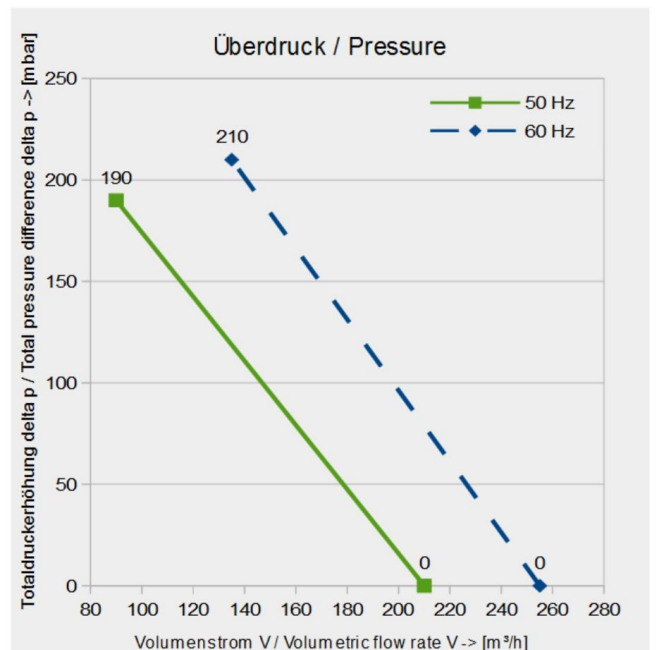
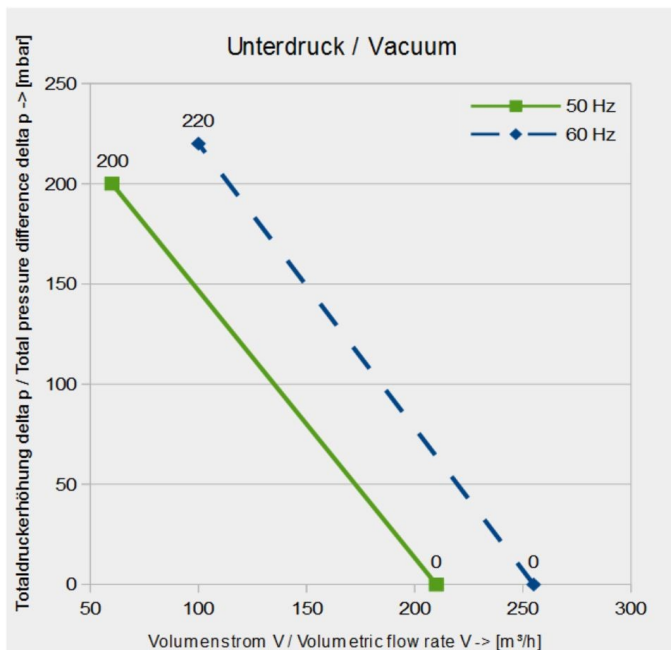

## Abmessungen / Construction datas

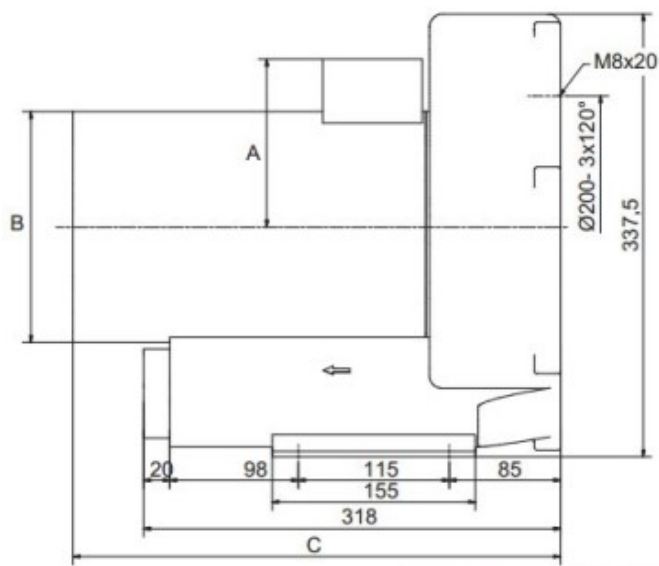

Motor	A	B	C
1,1 kW / 1,3 kW	120	Ø156	315
1,5 kW / 1,8 kW	128	Ø176	346
2,2 kW / 2,55 kW	128	Ø176	372

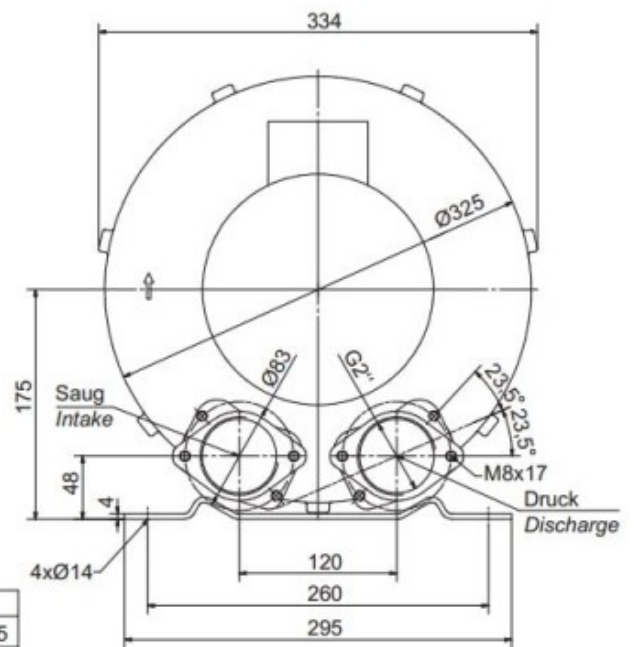

## Gerätetyp / Similar machine types

Frequenz Frequency	Grenzwerte der Drosselkurve Überdruck		Grenzwerte der Drosselkurve Unterdruck		Nennwerte des Motors			Schalldruckpegel Sound pressure level	Gewicht (ca.) Weight (approx.)
	Maximum performance when used as blower		Maximum performance when used as extractor		Motor ratings				
	$\dot{V}$ max. $\dot{V}$ max.	$\Delta p_t$ max. $\Delta p_t$ max.	$\dot{V}$ max. $\dot{V}$ max.	$\Delta p_t$ max. $\Delta p_t$ max.	Leistung Rated output	Spannung Voltage	Strom Current		
Hz	m <sup>3</sup> /min	mbar	m <sup>3</sup> /min	mbar	kW	V	A	dB (A)	kg
50	3,50	120 / 170 <sup>1)</sup>	3,50	130 / 170 <sup>1)</sup>	1,1	230/400	4,0/2,3	64	22
60	4,25	140	4,25	150	1,3	277/480	4,5/2,6	70	22
50	3,50	190 / 190 <sup>1)</sup>	3,50	200 / 200 <sup>1)</sup>	1,5	230/400	5,5/3,2	64	23
60	4,25	210	4,25	220	1,8	277/480	5,5/3,15	70	23
50	3,50	270 / 270 <sup>1)</sup>	3,50	220 / 220 <sup>1)</sup>	2,2	230/400	7,5/4,3	64	25
60	4,25	290	4,25	260	2,55	277/480	10,0/5,8	70	25

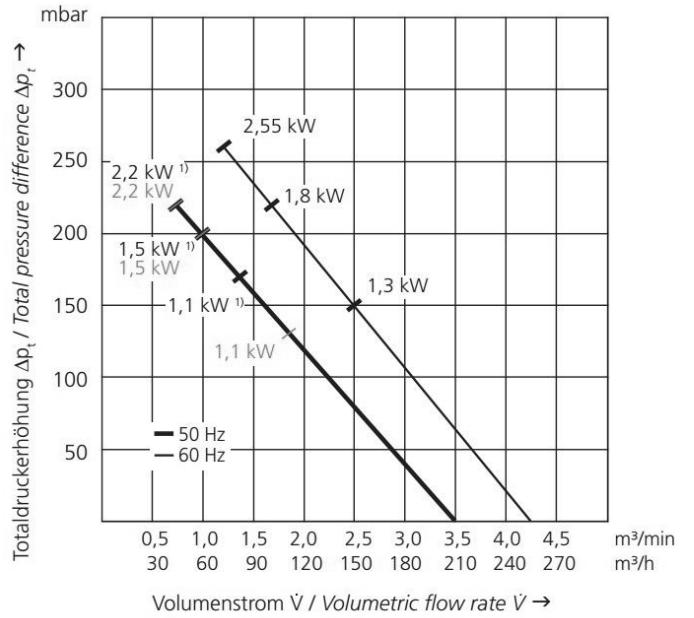
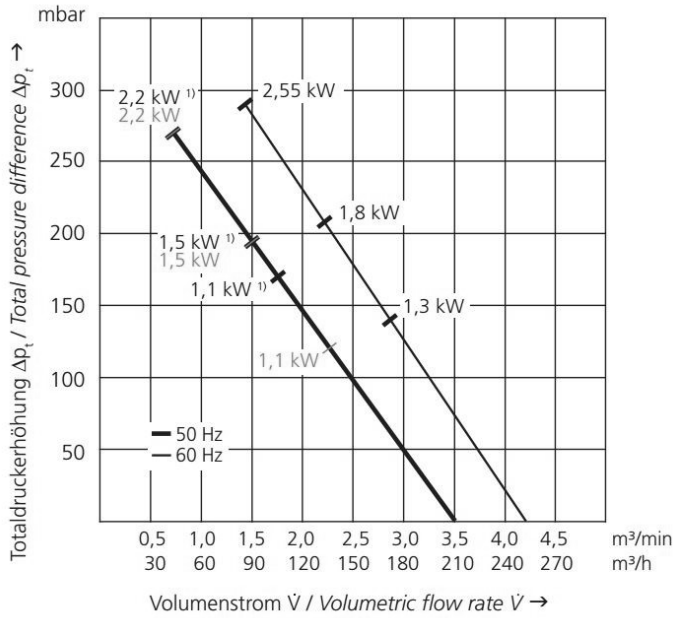

Fragen zum Artikel? Wir sind für Sie da!  
 03741 2510951 || [info@skvtechnik.de](mailto:info@skvtechnik.de)



**Verdichterkonfigurator** unter : <http://www.skvent.de>



**Konfigurator mit Lupe aufrufen!**